



## Description

The XPX6NN28XS uses advanced trench technology and design to provide excellent  $R_{DS(ON)}$  with low gate charge. It can be used in a wide variety of applications.

## General Features

- High density cell design for ultra low  $R_{dson}$
- Fully characterized avalanche voltage and current
- Good stability and uniformity with high  $E_{AS}$
- Excellent package for good heat dissipation

## Application

- Power switching application
- Hard switched and high frequency circuits
- Uninterruptible power supply

## FEATURE

- ◆ 60V/6.8A,  $R_{DS(ON)}=28m\Omega$  (typ.)@VGS= 10V
- ◆ 60V/5.0A,  $R_{DS(ON)}=32m\Omega$  (typ.)@VGS= 4.5V

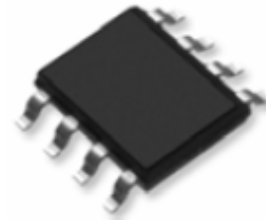
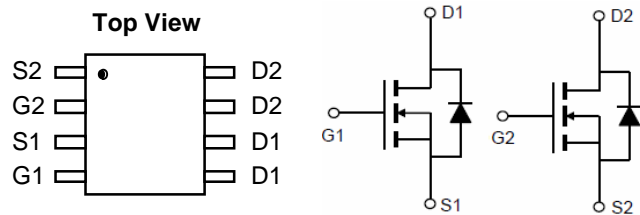

SOP-8

## Package Marking and Ordering Information

Device Marking	Device	Device Package	Reel Size	Tape width	Quantity
XPX6NN28XS	XPX6NN28XS	SOP-8	Ø330mm	12mm	3000 units

## Absolute Maximum Ratings ( $T_A=25^\circ\text{C}$ unless otherwise noted)

Parameter	Symbol	Limit	Unit
Drain-Source Voltage	$V_{DS}$	60	V
Gate-Source Voltage	$V_{GS}$	$\pm 20$	V
Drain Current-Continuous	$I_D$	6.8	A
Drain Current-Continuous( $T_C=100^\circ\text{C}$ )	$I_D(100^\circ\text{C})$	5.0	A
Pulsed Drain Current	$I_{DM}$	28	A
Maximum Power Dissipation	$P_D$	2.3	W
Operating Junction and Storage Temperature Range	$T_J, T_{STG}$	-55 To 150	$^\circ\text{C}$
Thermal Resistance, Junction-to-Ambient <sup>(Note 2)</sup>	$R_{\theta JA}$	64	$^\circ\text{C/W}$

**Electrical Characteristics (T<sub>A</sub>=25°C unless otherwise noted)**

Parameter	Symbol	Condition	Min	Typ	Max	Unit
<b>Off Characteristics</b>						
Drain-Source Breakdown Voltage	BV <sub>DSS</sub>	V <sub>GS</sub> =0V, I <sub>D</sub> =250μA	60	-	-	V
Zero Gate Voltage Drain Current	I <sub>DSS</sub>	V <sub>DS</sub> =60V, V <sub>GS</sub> =0V	-	-	1	μA
Gate-Body Leakage Current	I <sub>GSS</sub>	V <sub>GS</sub> =±20V, V <sub>DS</sub> =0V	-	-	±100	nA
<b>On Characteristics</b> (Note 3)						
Gate Threshold Voltage	V <sub>GS(th)</sub>	V <sub>DS</sub> =V <sub>GS</sub> , I <sub>D</sub> =250μA	1.2	1.6	2.5	V
Drain-Source On-State Resistance	R <sub>DS(on)</sub>	V <sub>GS</sub> =10V, I <sub>D</sub> =6.8A	-	28	35	mΩ
	R <sub>DS(on)</sub>	V <sub>GS</sub> =4.5V, I <sub>D</sub> =5A	-	32	45	mΩ
Forward Transconductance	g <sub>FS</sub>	V <sub>DS</sub> =5V, I <sub>D</sub> =5A	11	-	-	S
<b>Dynamic Characteristics</b> (Note 4)						
Input Capacitance	C <sub>iss</sub>	V <sub>DS</sub> =30V, V <sub>GS</sub> =0V, F=1.0MHz	-	998	-	PF
Output Capacitance	C <sub>oss</sub>		-	125	-	PF
Reverse Transfer Capacitance	C <sub>rss</sub>		-	108	-	PF
<b>Switching Characteristics</b> (Note 4)						
Turn-on Delay Time	t <sub>d(on)</sub>	V <sub>DD</sub> =30V, R <sub>L</sub> =6.7Ω V <sub>GS</sub> =10V, R <sub>G</sub> =3Ω	-	5.5	-	nS
Turn-on Rise Time	t <sub>r</sub>		-	3.2	-	nS
Turn-Off Delay Time	t <sub>d(off)</sub>		-	17	-	nS
Turn-Off Fall Time	t <sub>f</sub>		-	2.5	-	nS
Total Gate Charge	Q <sub>g</sub>	V <sub>DS</sub> =30V, I <sub>D</sub> =5A, V <sub>GS</sub> =10V	-	22	-	nC
Gate-Source Charge	Q <sub>gs</sub>		-	3.3	-	nC
Gate-Drain Charge	Q <sub>gd</sub>		-	5.2	-	nC
<b>Drain-Source Diode Characteristics</b>						
Diode Forward Voltage (Note 3)	V <sub>SD</sub>	V <sub>GS</sub> =0V, I <sub>S</sub> =5A	-	-	1.2	V
Diode Forward Current (Note 2)	I <sub>S</sub>		-	-	5	A
Forward Turn-On Time	t <sub>on</sub>	Intrinsic turn-on time is negligible (turn-on is dominated by LS+LD)				

**Notes:**

1. Repetitive Rating: Pulse width limited by maximum junction temperature.
2. Surface Mounted on FR4 Board, t ≤ 10 sec.
3. Pulse Test: Pulse Width ≤ 300μs, Duty Cycle ≤ 2%.
4. Guaranteed by design, not subject to production
5. EAS condition: T<sub>j</sub>=25°C, V<sub>DD</sub>=30V, V<sub>G</sub>=10V, L=0.5mH, R<sub>G</sub>=25Ω

■ **TYPICAL CHARACTERISTICS (25 °C Unless Note)**

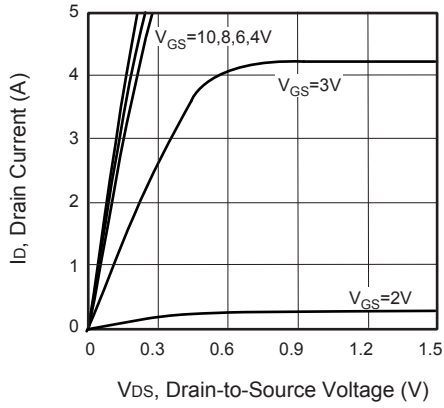

Figure 1. Output Characteristics

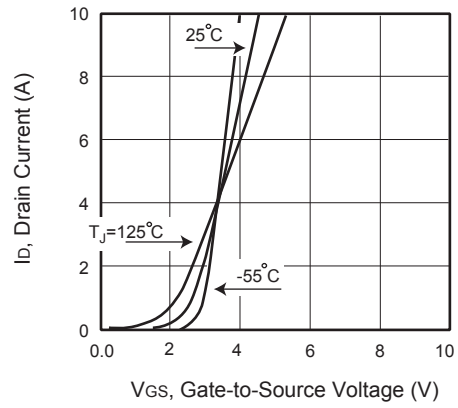

Figure 2. Transfer Characteristics

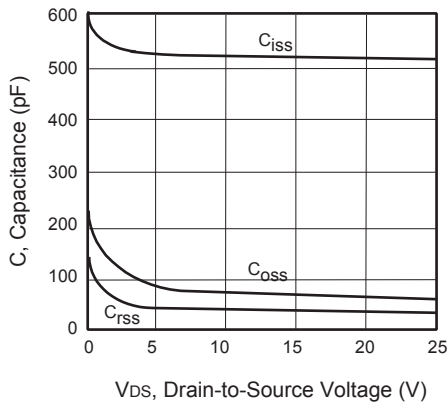

Figure 3. Capacitance

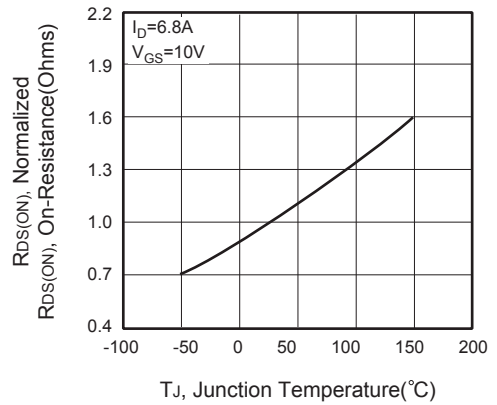

Figure 4. On-Resistance Variation with Temperature

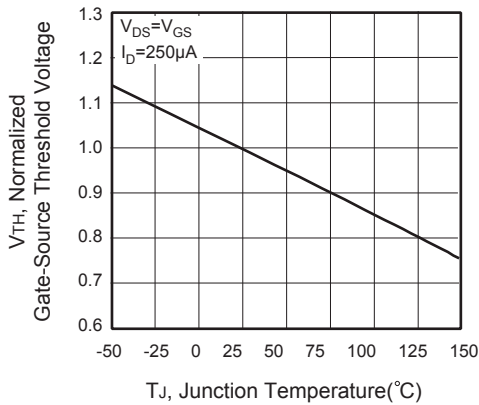

Figure 5. Gate Threshold Variation with Temperature

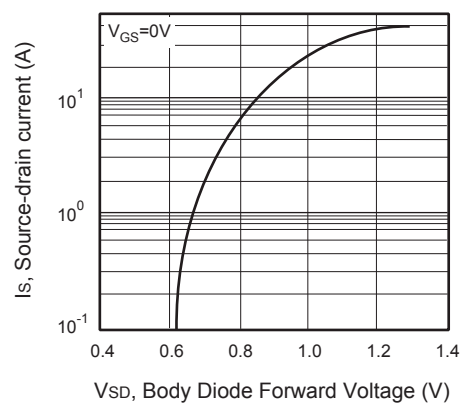

Figure 6. Body Diode Forward Voltage Variation with Source Current

60V N+N-Channel Enhancement Mode MOSFET

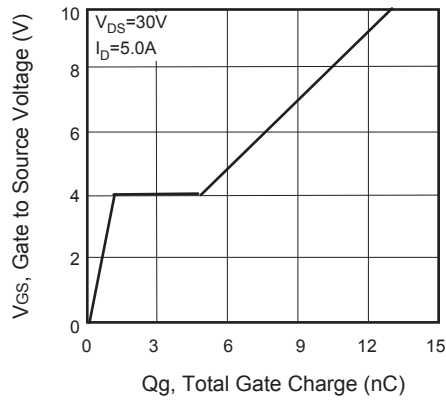

Figure 7. Gate Charge

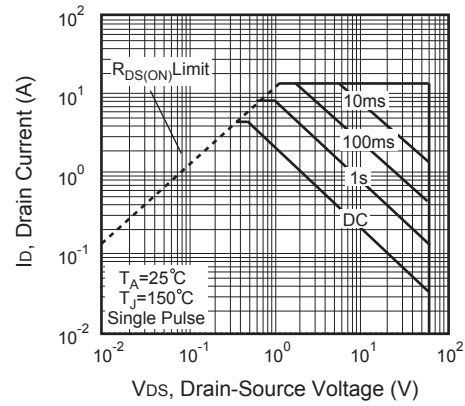

Figure 8. Maximum Safe Operating Area

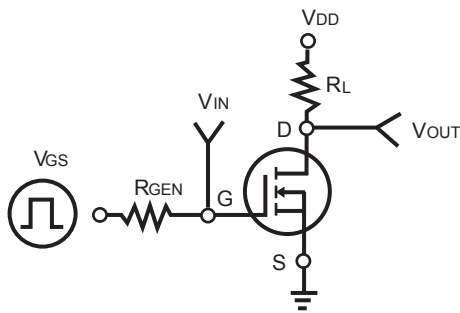

Figure 9. Switching Test Circuit

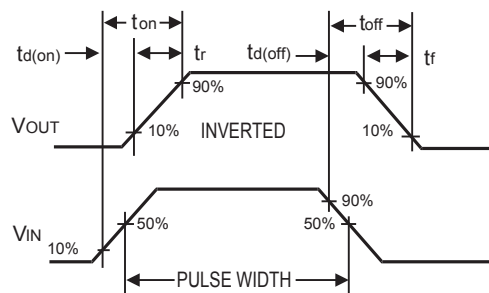

Figure 10. Switching Waveforms

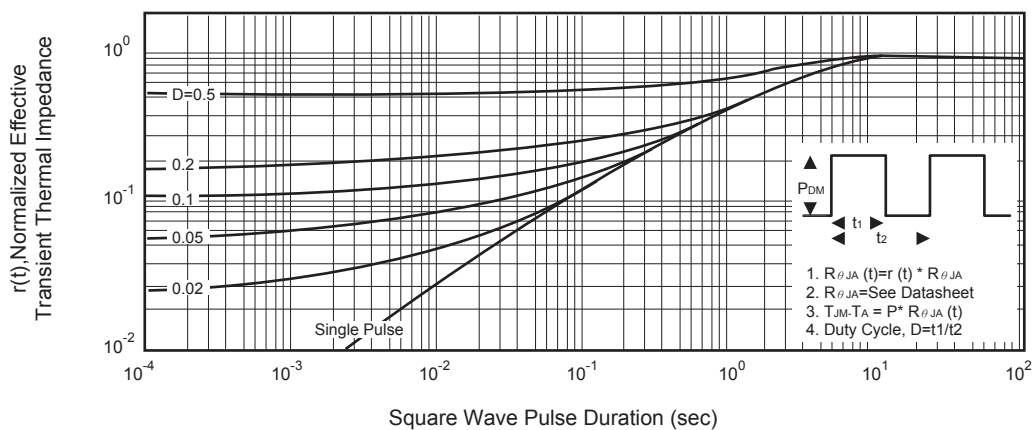
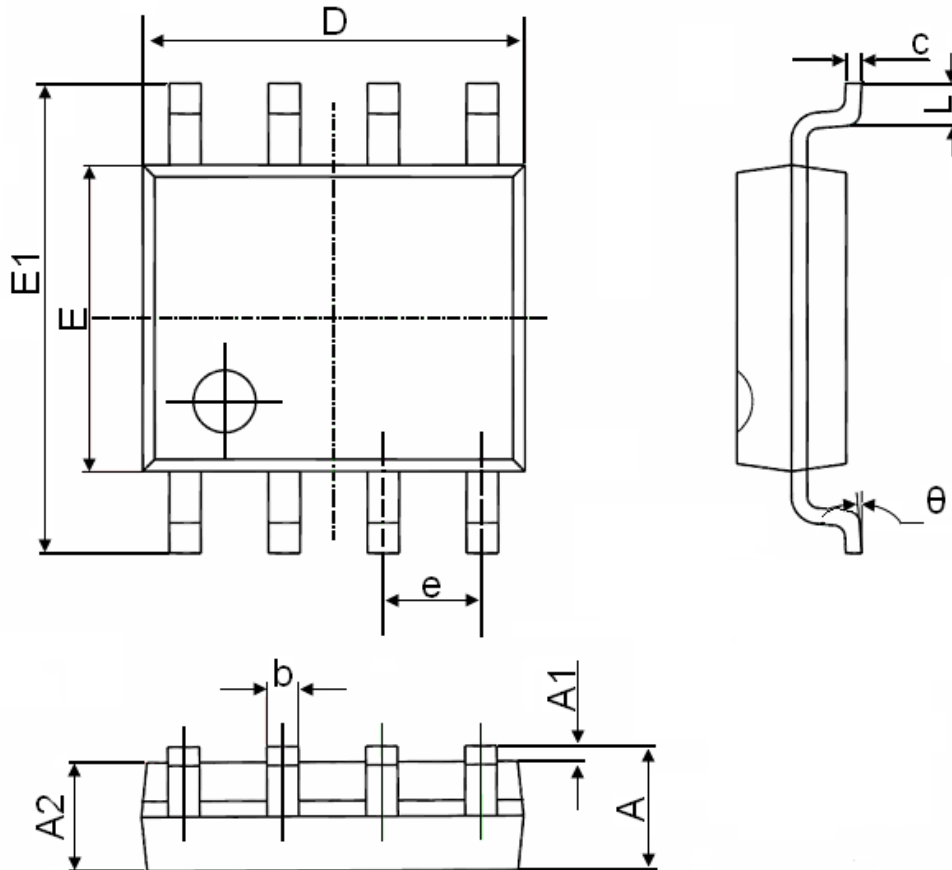

Figure 11. Normalized Thermal Transient Impedance Curve

SOP-8 Package Information



Symbol	Dimensions In Millimeters		Dimensions In Inches	
	Min.	Max.	Min.	Max.
A	1.350	1.750	0.053	0.069
A1	0.100	0.250	0.004	0.010
A2	1.350	1.550	0.053	0.061
b	0.330	0.510	0.013	0.020
c	0.170	0.250	0.006	0.010
D	4.700	5.100	0.185	0.200
E	3.800	4.000	0.150	0.157
E1	5.800	6.200	0.228	0.244
e	1.270(BSC)		0.050(BSC)	
L	0.400	1.270	0.016	0.050
θ	0°	8°	0°	8°

**60V N+N-Channel Enhancement Mode MOSFET**

Flow (wave) soldering (solder dipping)

Product	Peak Temperature	Dipping Time
Pb device	245°C ±5°C	5sec±1sec
Pb-Free device	260°C +0/-5°C	5sec±1sec



This integrated circuit can be damaged by ESD. UniverChip Corporation recommends that all integrated circuits be handled with appropriate precautions. Failure to observe proper handling and installation procedure can cause damage. ESD damage can range from subtle performance degradation to complete device failure. Precision integrated circuits may be more susceptible to damage because very small parametric changes could cause the device not to meet its published specifications.

**Attention:**

- Any and all XPX power products described or contained herein do not have specifications that can handle applications that require extremely high levels of reliability, such as life-support systems, aircraft's control systems, or other applications whose failure can be reasonably expected to result in serious physical and/or material damage. Consult with your XPX power representative nearest you before using any XPX power products described or contained herein in such applications.
- XPX power assumes no responsibility for equipment failures that result from using products at values that exceed, even momentarily, rated values (such as maximum ratings, operating condition ranges, or other parameters) listed in products specifications of any and all XPX power products described or contained herein.
- Specifications of any and all XPX power products described or contained herein stipulate the performance, characteristics, and functions of the described products in the independent state, and are not guarantees of the performance, characteristics, and functions of the described products as mounted in the customer's products or equipment. To verify symptoms and states that cannot be evaluated in an independent device, the customer should always evaluate and test devices mounted in the customer's products or equipment.
- XPX power Semiconductor CO.,LTD. strives to supply high-quality high-reliability products. However, any and all semiconductor products fail with some probability. It is possible that these probabilistic failures could give rise to accidents or events that could endanger human lives, that could give rise to smoke or fire, or that could cause damage to other property. When designing equipment, adopt safety measures so that these kinds of accidents or events cannot occur. Such measures include but are not limited to protective circuits and error prevention circuits for safe design, redundant design, and structural design.
- In the event that any or all XPX power products(including technical data, services) described or contained herein are controlled under any of applicable local export control laws and regulations, such products must not be exported without obtaining the export license from the authorities concerned in accordance with the above law.
- No part of this publication may be reproduced or transmitted in any form or by any means, electronic or mechanical, including photocopying and recording, or any information storage or retrieval system, or otherwise, without the prior written permission of XPX power Semiconductor CO.,LTD.
- Information (including circuit diagrams and circuit parameters) herein is for example only ; it is not guaranteed for volume production. XPX power believes information herein is accurate and reliable, but no guarantees are made or implied regarding its use or any infringements of intellectual property rights or other rights of third parties.
- Any and all information described or contained herein are subject to change without notice due to product/ technology improvement, etc. When designing equipment, refer to the "Delivery Specification" for the XPX power product that you intend to use.
- This catalog provides information as of Sep.2019. Specifications and information herein are subject to change without notice.