



Description

The XPX028N03FD uses advanced trench technology and design to provide excellent $R_{DS(ON)}$ with low gate charge. It can be used in a wide variety of applications.

$V_{DS} = 30V, I_D = 100A$

$R_{DS(ON)} = 2.8m\Omega$ (typ) @ $V_{GS} = 10V$

$R_{DS(ON)} = 4.5m\Omega$ (typ) @ $V_{GS} = 4.5V$

General Features

- High density cell design for ultra low R_{dson}
- Fully characterized avalanche voltage and current
- Good stability and uniformity with high E_{AS}
- Excellent package for good heat dissipation

Application

- PWM
- Load Switching

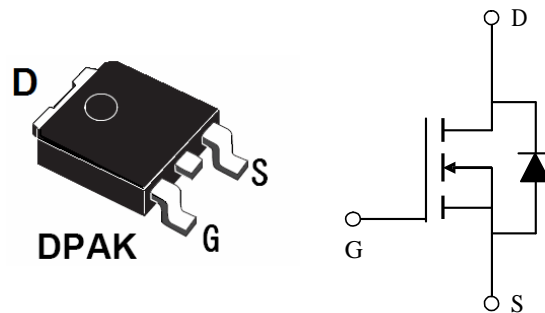

Package Marking and Ordering Information

Device Marking	Device	Device Package	Reel Size	Tape width	Quantity
XPX028N03FD	XPX028N03FD	DFN 3x3-8	-	-	5000

Absolute Maximum Ratings ($T_C = 25^\circ C$ unless otherwise noted)

Parameter	Symbol	Limit	Unit
Drain-Source Voltage	V_{DS}	30	V
Gate-Source Voltage	V_{GS}	± 20	V
Drain Current-Continuous	I_D	100	A
Drain Current-Continuous ($T_C = 100^\circ C$)	$I_D(100^\circ C)$	65	A
Pulsed Drain Current ^(Note 1)	I_{DM}	350	A
Maximum Power Dissipation	P_D	70	W
Derating factor		3.2	W/ $^\circ C$
Single pulse avalanche energy ^(Note 5)	E_{AS}	121	mJ
Operating Junction and Storage Temperature Range	T_J, T_{STG}	-55 To 150	$^\circ C$
Thermal Resistance, Junction-to-Case ^(Note 2)	$R_{\theta JC}$	2.15	$^\circ C/W$

Electrical Characteristics ($T_A = 25^\circ\text{C}$ unless otherwise noted)

Symbol	Parameter	Test Conditions	Min.	Typ.	Max.	Unit
Static Characteristics						
BV_{DSS}	Drain-Source Breakdown Voltage	$V_{GS}=0V, I_{DS}=250\mu A$	30	-	-	V
I_{DSS}	Zero Gate Voltage Drain Current	$V_{DS}=24V, V_{GS}=0V$	-	-	1	μA
		$T_J=85^\circ C$	-	-	30	
$V_{GS(th)}$	Gate Threshold Voltage	$V_{DS}=V_{GS}, I_{DS}=250\mu A$	1.0	1.5	2.5	V
I_{GSS}	Gate Leakage Current	$V_{GS}=\pm 20V, V_{DS}=0V$	-	-	± 100	nA
$R_{DS(ON)}^d$	Drain-Source On-state Resistance	$V_{GS}=10V, I_{DS}=20A$	-	2.8	3.8	m Ω
		$T_J=125^\circ C$	-	4.4	-	
		$V_{GS}=4.5V, I_{DS}=20A$	-	4.5	5.5	
Gfs	Forward Transconductance	$V_{DS}=5V, I_{DS}=20A$	-	24.6	-	S
Diode Characteristics						
V_{SD}^d	Diode Forward Voltage	$I_{SD}=20A, V_{GS}=0V$	-	0.8	1.1	V
t_{rr}	Reverse Recovery Time	$I_{DS}=20A, dI_{SD}/dt=100A/\mu s$	-	35.6	-	ns
t_a	Charge Time		-	19.3	-	
t_b	Discharge Time		-	16.3	-	
Q_{rr}	Reverse Recovery Charge		-	26	-	
Dynamic Characteristics^e						
R_G	Gate Resistance	$V_{GS}=0V, V_{DS}=0V, F=1MHz$	-	1	2	Ω
C_{iss}	Input Capacitance	$V_{GS}=0V,$ $V_{DS}=15V,$ Frequency=1.0MHz	-	1968	2818	pF
C_{oss}	Output Capacitance		-	850	-	
C_{rss}	Reverse Transfer Capacitance		-	185	-	
$t_{d(ON)}$	Turn-on Delay Time	$V_{DD}=15V, R_L=15\Omega,$ $I_{DS}=1A, V_{GEN}=10V,$ $R_G=6\Omega$	-	12.4	23	ns
t_r	Turn-on Rise Time		-	9.5	18	
$t_{d(OFF)}$	Turn-off Delay Time		-	27.2	49	
t_f	Turn-off Fall Time		-	35.2	64	
Gate Charge Characteristics^e						
Q_g	Total Gate Charge	$V_{DS}=15V, V_{GS}=10V,$ $I_{DS}=20A$	-	20.6	28.8	nC
Q_g	Total Gate Charge	$V_{DS}=15V, V_{GS}=4.5V,$ $I_{DS}=20A$	-	9.8	-	
Q_{gth}	Threshold Gate Charge		-	1.8	-	
Q_{gs}	Gate-Source Charge		-	3.8	-	
Q_{gd}	Gate-Drain Charge		-	3.7	-	

Note d : Pulse test ; pulse width $\leq 300\mu s$, duty cycle $\leq 2\%$.

Note e : Guaranteed by design, not subject to production testing.

Typical Operating Characteristics

Power Dissipation

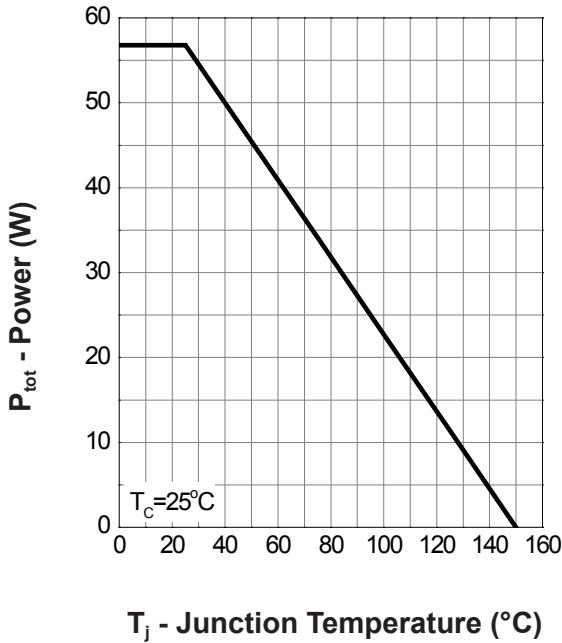

Drain Current

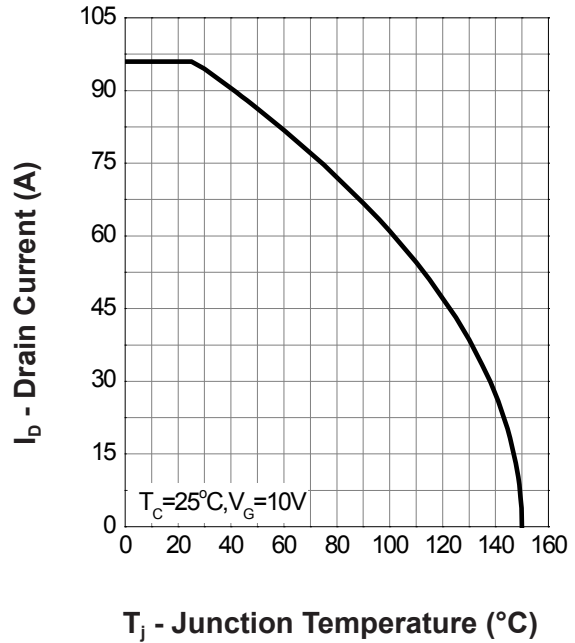

Safe Operation Area

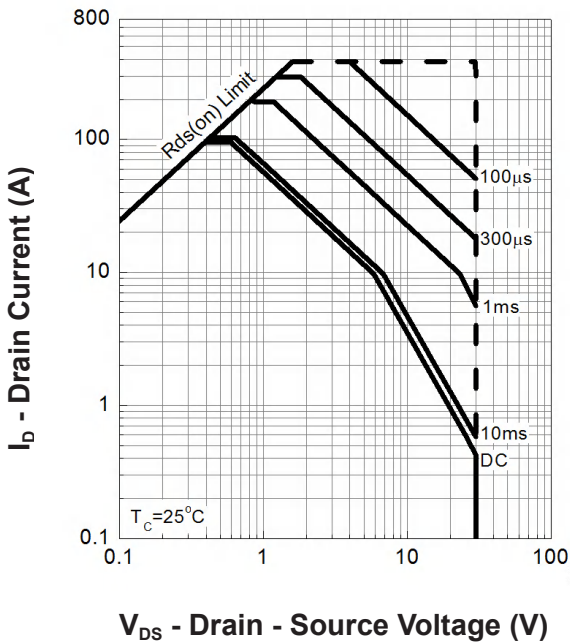

Thermal Transient Impedance

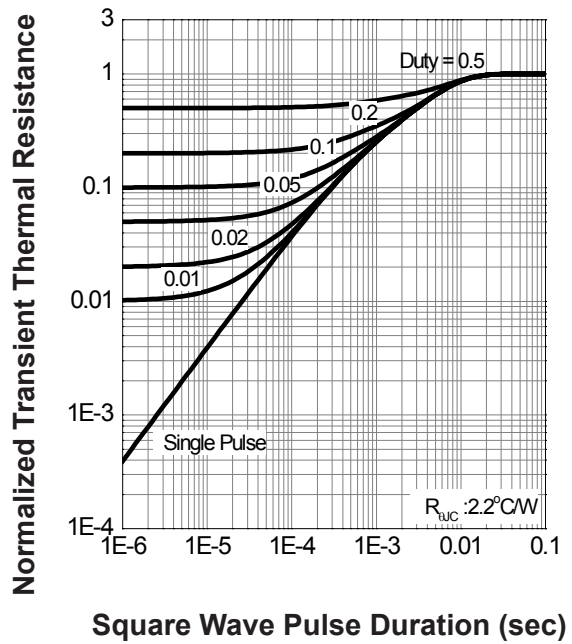

Typical Operating Characteristics(Cont.)

Safe Operation Area

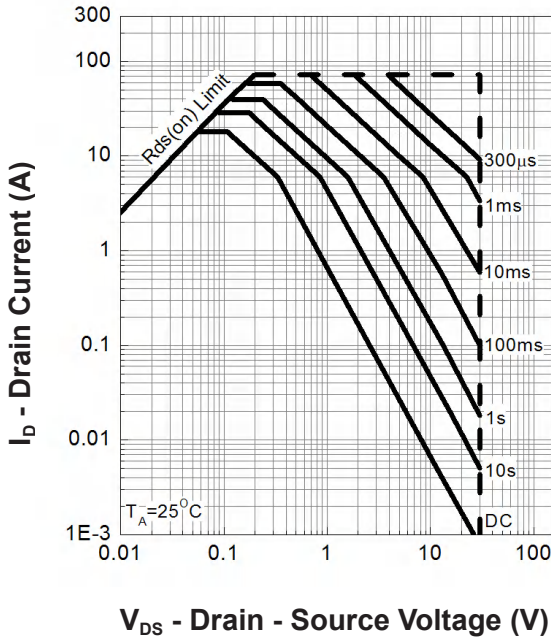

Thermal Transient Impedance

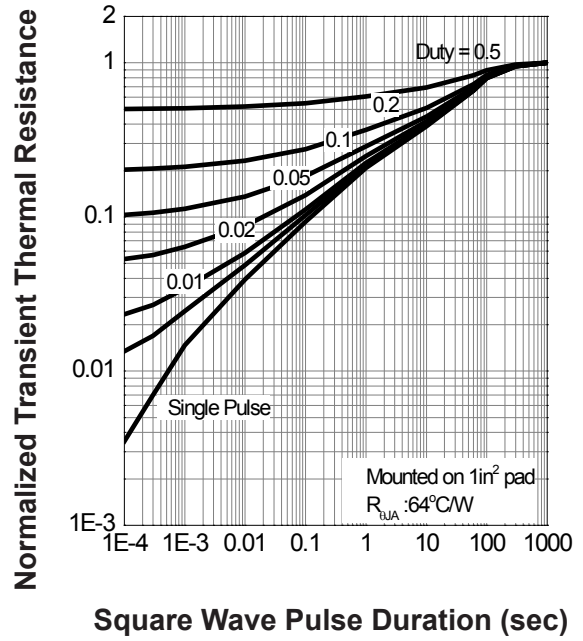

Output Characteristics

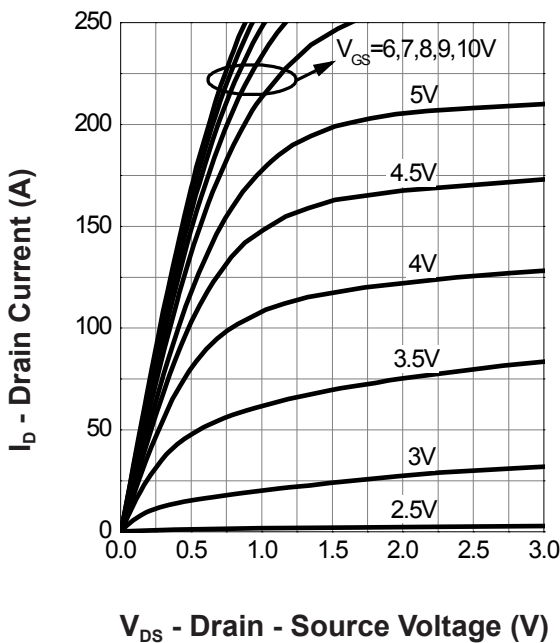

Drain-Source On Resistance

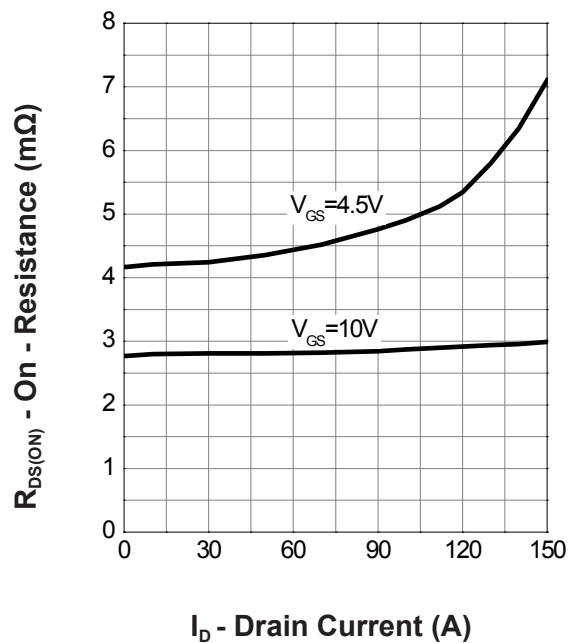

Typical Operating Characteristics(Cont.)

Gate-Source On Resistance

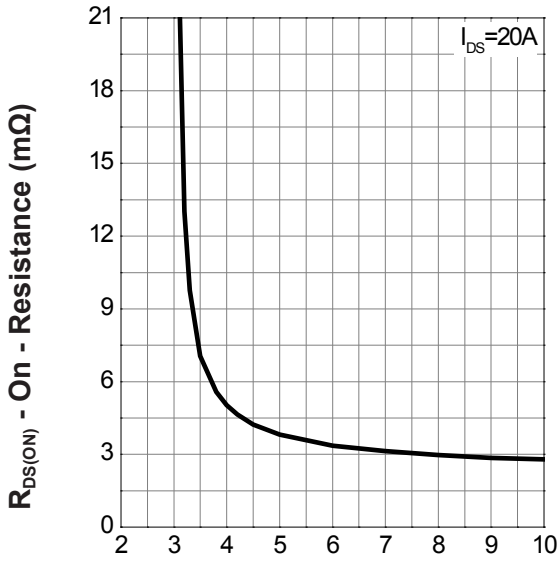

V_{GS} - Gate - Source Voltage (V)

Gate Threshold Voltage

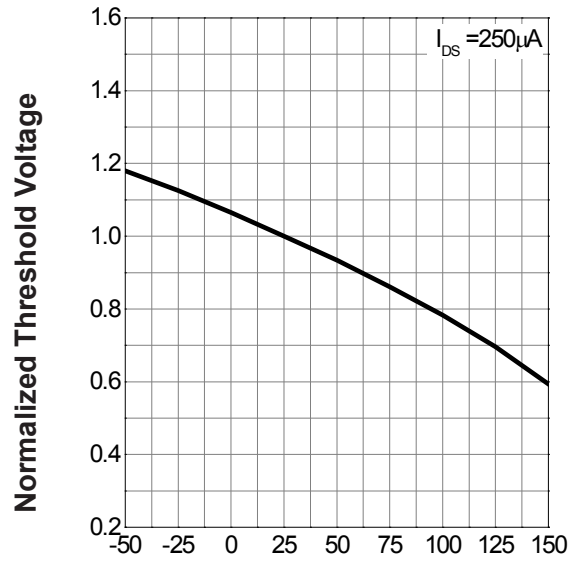

T_J - Junction Temperature (°C)

Drain-Source On Resistance

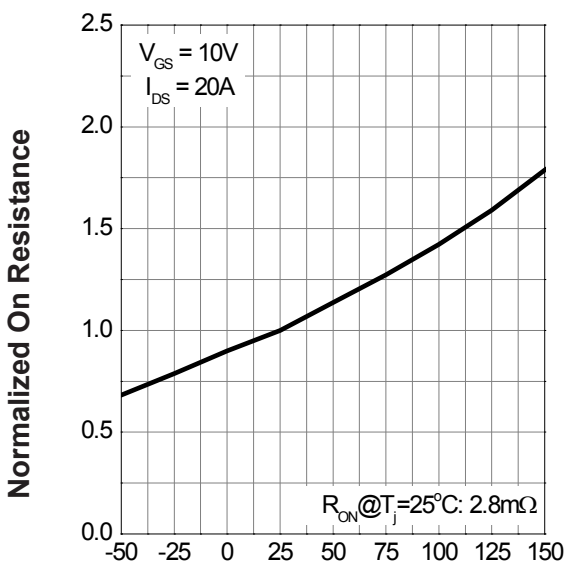

T_J - Junction Temperature (°C)

Source-Drain Diode Forward

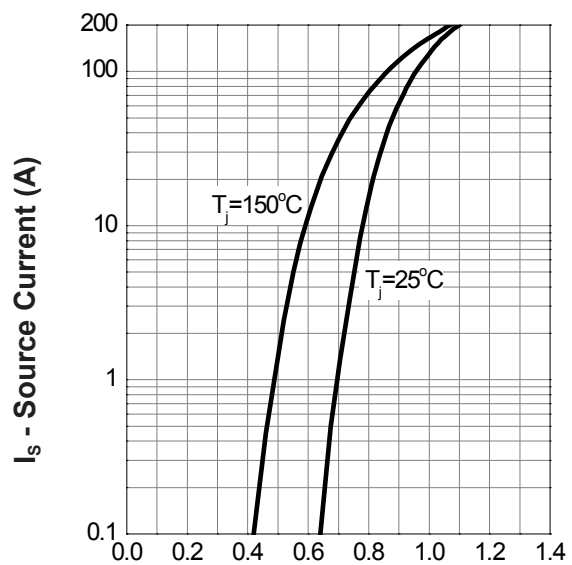

V_{SD} - Source - Drain Voltage (V)

Typical Operating Characteristics(Cont.)

Capacitance

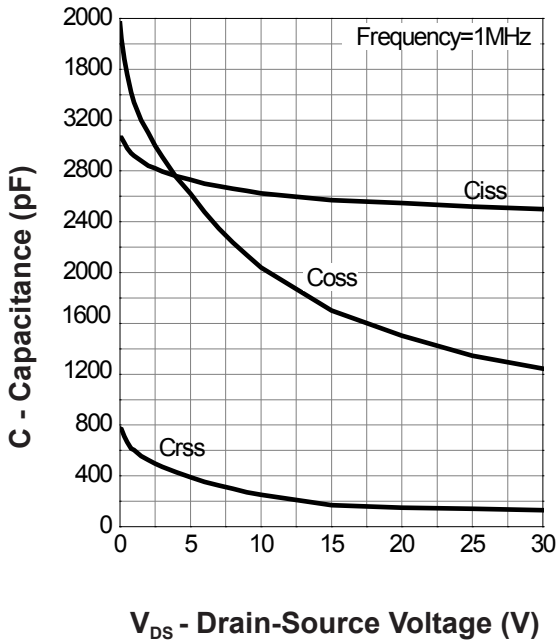

Gate Charge

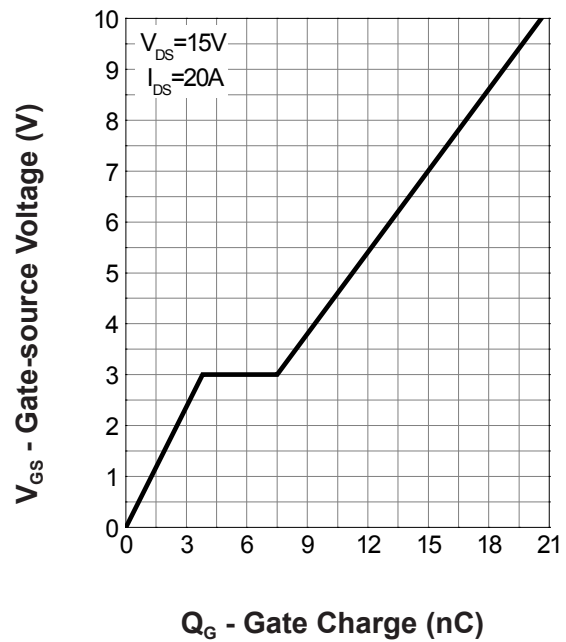

Transfer Characteristics

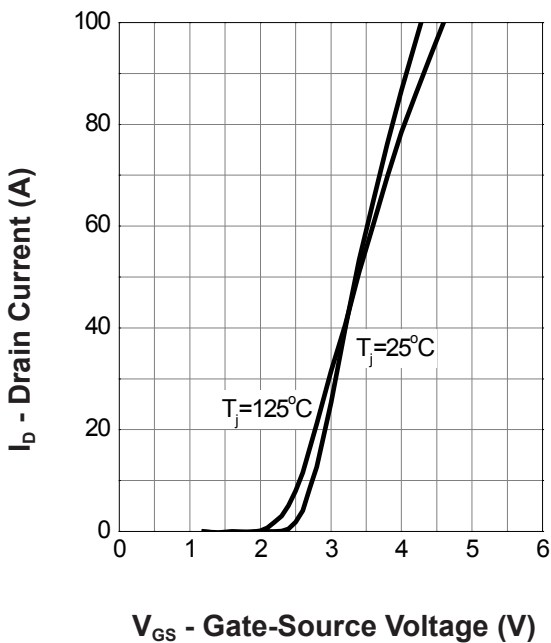

Package Mechanical Data: TO-252-3L

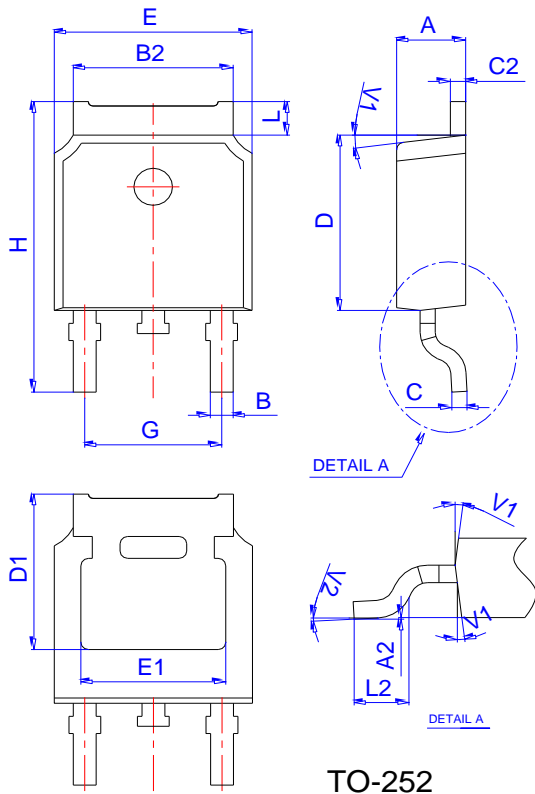

Ref.	Dimensions					
	Millimeters			Inches		
	Min.	Typ.	Max.	Min.	Typ.	Max.
A	2.10		2.50	0.083		0.098
A2	0		0.10	0		0.004
B	0.66		0.86	0.026		0.034
B2	5.18		5.48	0.202		0.216
C	0.40		0.60	0.016		0.024
C2	0.44		0.58	0.017		0.023
D	5.90		6.30	0.232		0.248
D1	5.30REF			0.209REF		
E	6.40		6.80	0.252		0.268
E1	4.63			0.182		
G	4.47		4.67	0.176		0.184
H	9.50		10.70	0.374		0.421
L	1.09		1.21	0.043		0.048
L2	1.35		1.65	0.053		0.065
V1		7°			7°	
V2		0°	6°	0°	7°	6°

Reel Specification-TO-252

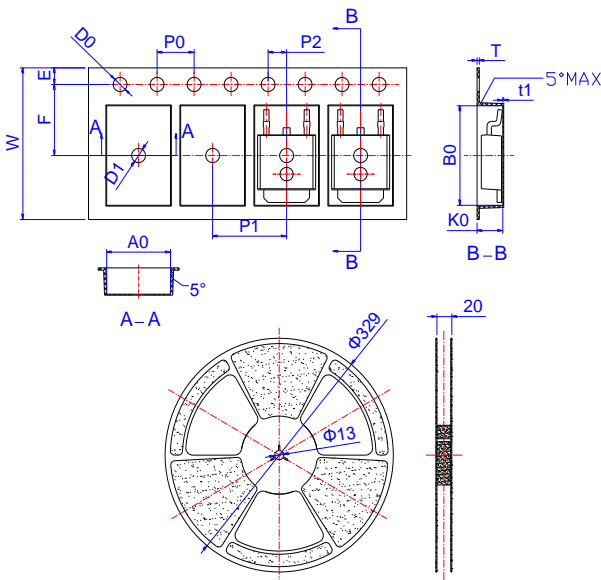

Ref.	Dimensions					
	Millimeters			Inches		
	Min.	Typ.	Max.	Min.	Typ.	Max.
W	15.90	16.00	16.10	0.626	0.630	0.634
E	1.65	1.75	1.85	0.065	0.069	0.073
F	7.40	7.50	7.60	0.291	0.295	0.299
D0	1.40	1.50	1.60	0.055	0.059	0.063
D1	1.40	1.50	1.60	0.055	0.059	0.063
P0	3.90	4.00	4.10	0.154	0.157	0.161
P1	7.90	8.00	8.10	0.311	0.315	0.319
P2	1.90	2.00	2.10	0.075	0.079	0.083
A0	6.85	6.90	7.00	0.270	0.271	0.276
B0	10.45	10.50	10.60	0.411	0.413	0.417
K0	2.68	2.78	2.88	0.105	0.109	0.113
T	0.24		0.27	0.009		0.011
t1	0.10			0.004		
10P0	39.80	40.00	40.20	1.567	1.575	1.583

30V N-Channel Enhancement Mode Power MOSFET

Flow (wave) soldering (solder dipping)

Product	Peak Temperature	Dipping Time
Pb device	245°C ±5°C	5sec ±1sec
Pb-Free device	260°C +0/-5°C	5sec ±1sec



This integrated circuit can be damaged by ESD. UniverChip Corporation recommends that all integrated circuits be handled with appropriate precautions. Failure to observe proper handling and installation procedure can cause damage. ESD damage can range from subtle performance degradation to complete device failure. Precision integrated circuits may be more susceptible to damage because very small parametric changes could cause the device not to meet its published specifications.

Attention:

- Any and all XPX power products described or contained herein do not have specifications that can handle applications that require extremely high levels of reliability, such as life-support systems, aircraft's control systems, or other applications whose failure can be reasonably expected to result in serious physical and/or material damage. Consult with your XPX power representative nearest you before using any XPX power products described or contained herein in such applications.
- XPX power assumes no responsibility for equipment failures that result from using products at values that exceed, even momentarily, rated values (such as maximum ratings, operating condition ranges, or other parameters) listed in products specifications of any and all XPX power products described or contained herein.
- Specifications of any and all XPX power products described or contained herein stipulate the performance, characteristics, and functions of the described products in the independent state, and are not guarantees of the performance, characteristics, and functions of the described products as mounted in the customer's products or equipment. To verify symptoms and states that cannot be evaluated in an independent device, the customer should always evaluate and test devices mounted in the customer's products or equipment.
- XPX power Semiconductor CO.,LTD. strives to supply high-quality high-reliability products. However, any and all semiconductor products fail with some probability. It is possible that these probabilistic failures could give rise to accidents or events that could endanger human lives, that could give rise to smoke or fire, or that could cause damage to other property. When designing equipment, adopt safety measures so that these kinds of accidents or events cannot occur. Such measures include but are not limited to protective circuits and error prevention circuits for safe design, redundant design, and structural design.
- In the event that any or all XPX power products(including technical data, services) described or contained herein are controlled under any of applicable local export control laws and regulations, such products must not be exported without obtaining the export license from the authorities concerned in accordance with the above law.
- No part of this publication may be reproduced or transmitted in any form or by any means, electronic or mechanical, including photocopying and recording, or any information storage or retrieval system, or otherwise, without the prior written permission of XPX power Semiconductor CO.,LTD.
- Information (including circuit diagrams and circuit parameters) herein is for example only ; it is not guaranteed for volume production. XPX power believes information herein is accurate and reliable, but no guarantees are made or implied regarding its use or any infringements of intellectual property rights or other rights of third parties.
- Any and all information described or contained herein are subject to change without notice due to product/ technology improvement, etc. When designing equipment, refer to the "Delivery Specification" for the XPX power product that you intend to use.
- This catalog provides information as of Sep.2019. Specifications and information herein are subject to change without notice.